

Saunatür Klarglas/Bronze Sauna door clear glass/bronze

DS40 & DS80

DS40-3CS-680, DS80-3CS-680, DS80-3BS-680

MONTAGEANWEISUNG / INSTALLATION INSTRUCTIONS

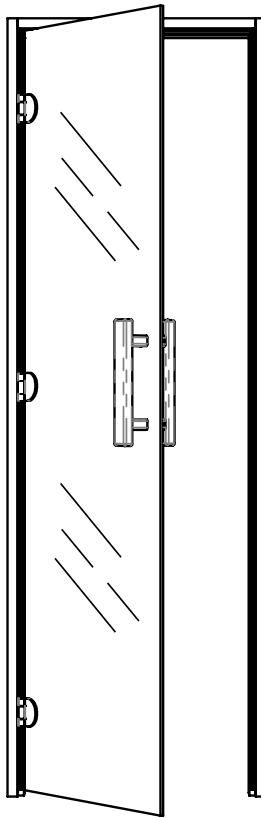

DE

EN

680 mm x 1915 mm

DS40-3CS-680

(mm)

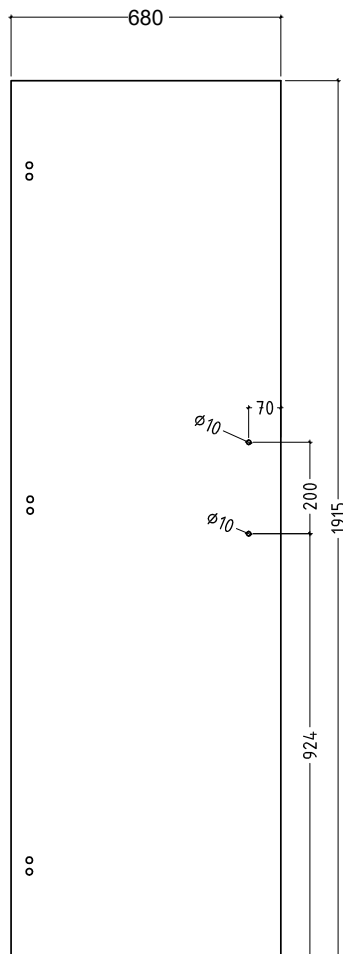
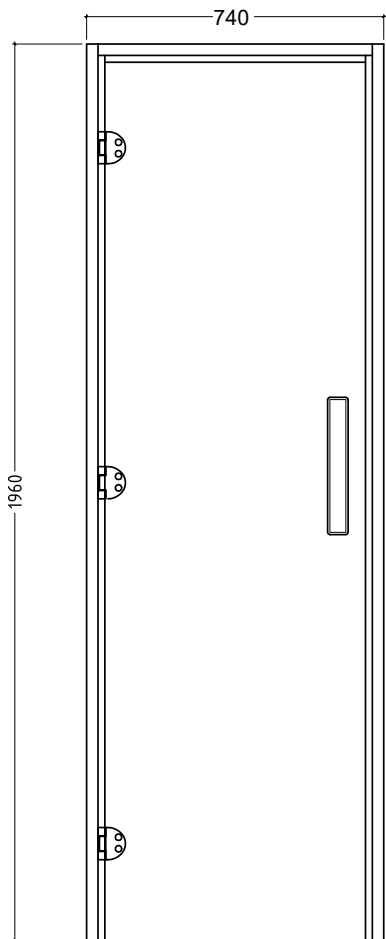
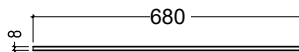
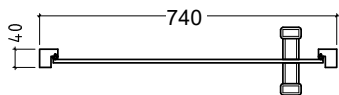

Einscheibensicherheitsglas (ESG) - tempered safety glass

DS80-3CS-680, DS80-3BS-680

(mm)

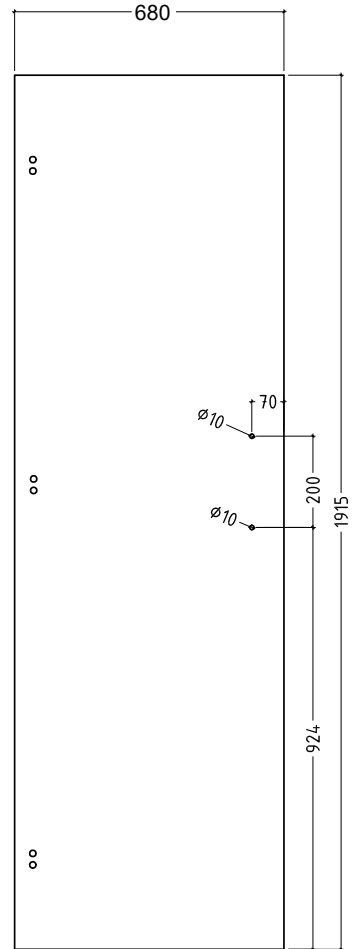
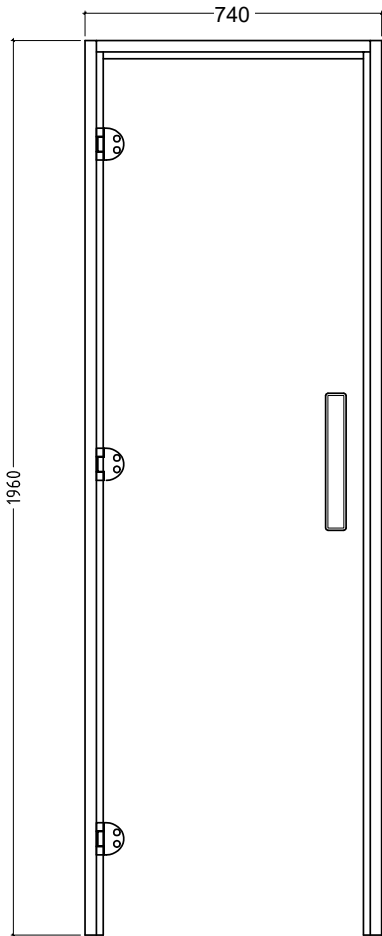
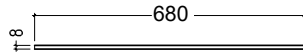
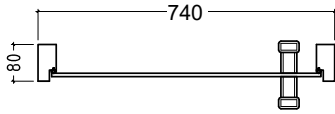

DE
EN

Einscheibensicherheitsglas (ESG) - tempered safety glass

Lieferumfang - Scope of supply

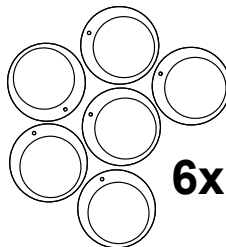
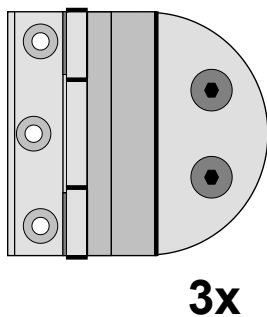
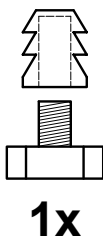
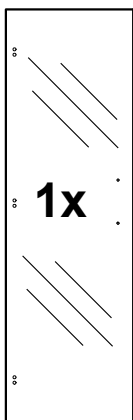
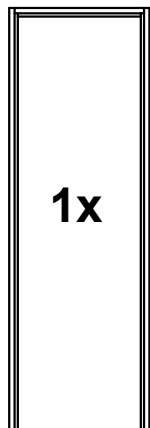

Montage - Installation

- ▶ Transportleiste entfernen - Remove the transport strip

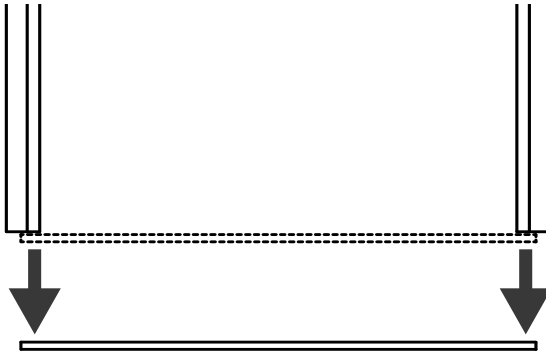
1

- ▶ Türrahmen montieren - Install door frame

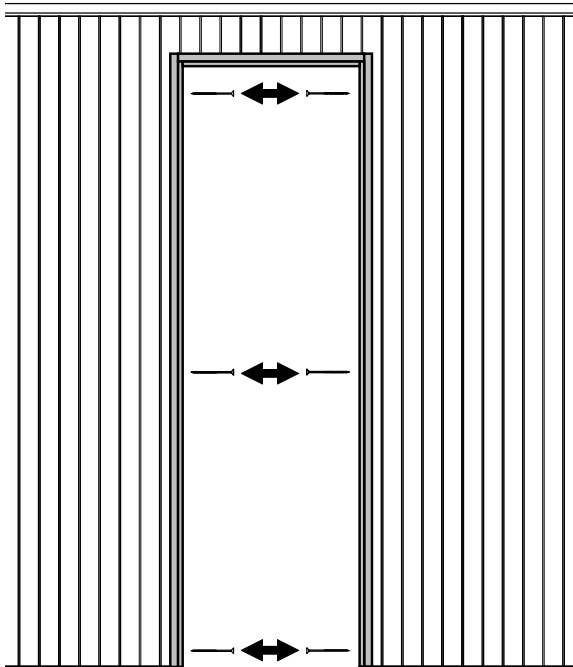
2

DE

EN

► Beschläge montieren - Assembling door mounting

3

Innenseite - inside

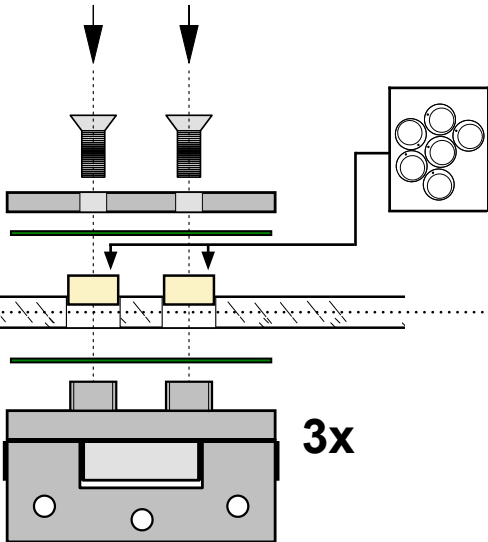
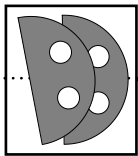

Außenseite - outside

3x

► Glastüre einsetzen - Insert glass door

4

Linksanschlag
Left stop

oder
or

Rechtsanschlag
Right stop

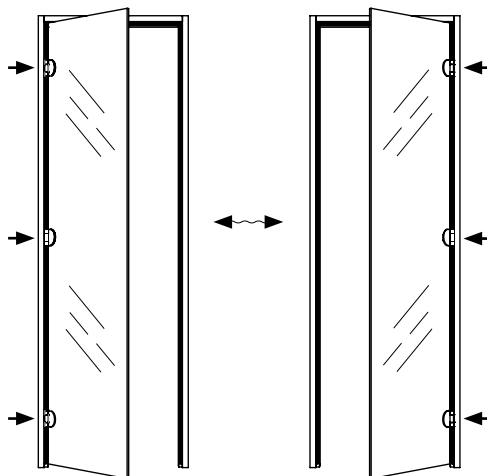

► Glastüre positionieren - Position glass door

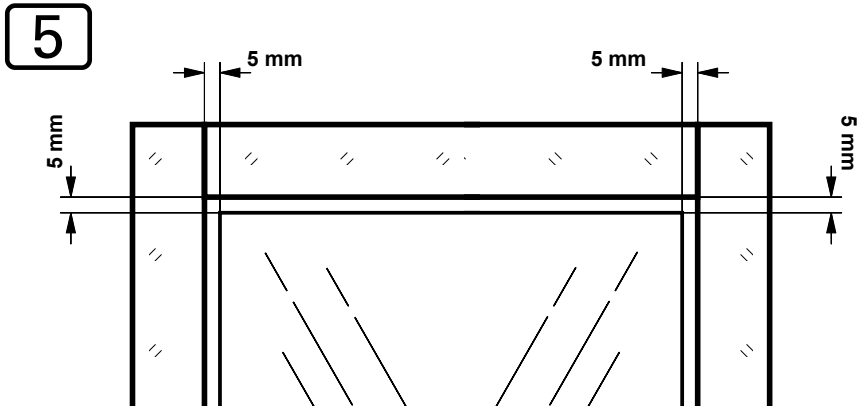

DE

EN

► Glastüre montieren - Mount glass door

6

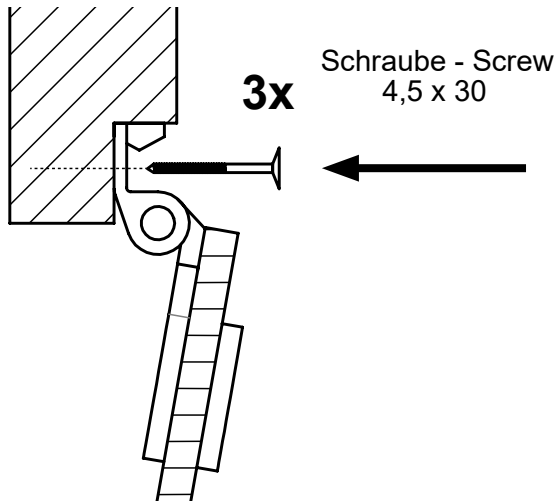

► Türgriff montieren - Mounting door handle

7

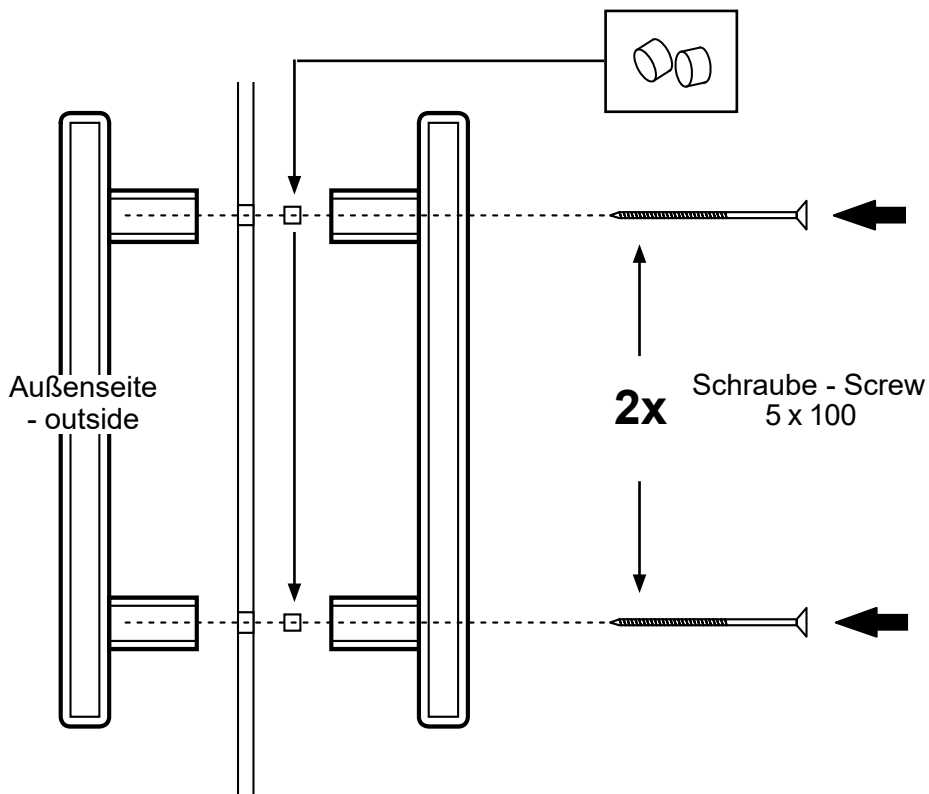

► Türmagnet montieren - Mounting door magnet

8

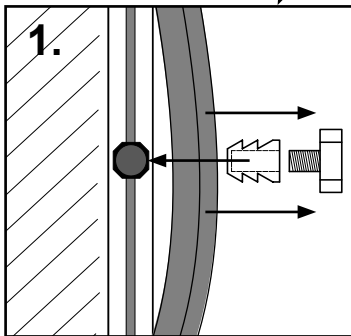
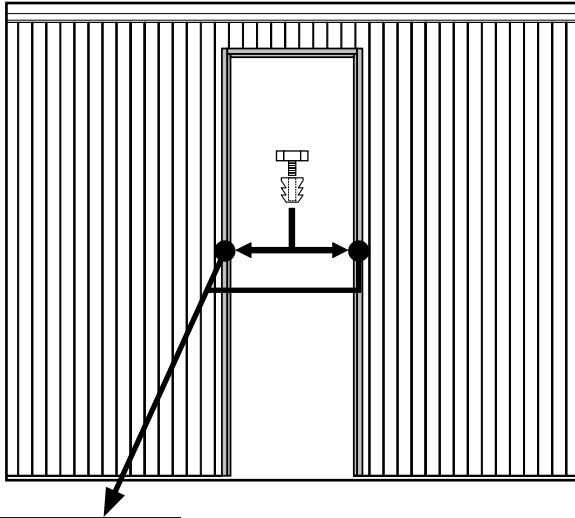

- Dichtband mittig abziehen und Türmagnet in Aussparung drücken.
- Pull sealing tape in the middle and press the door magnet into the hole.

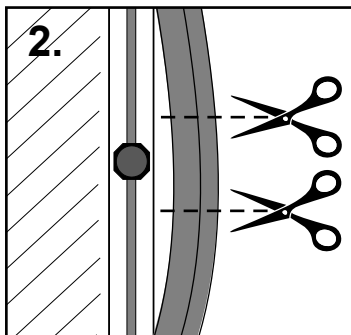

- Dichtband abschneiden.
- Cut the sealing tape.

DE

EN

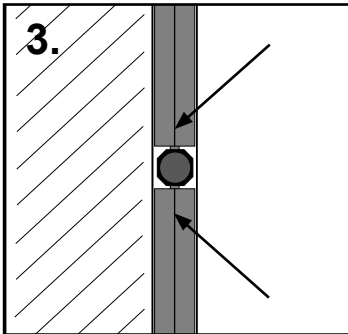

- ▶ Dichtband zurückdrücken.
- ▶ Push the sealing tape back.

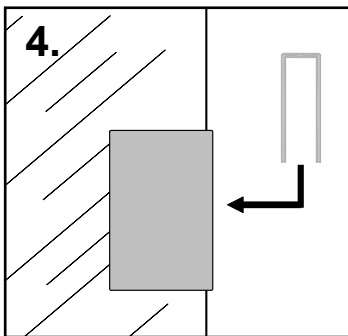

- ▶ Metallklammer auf Glasscheibe drücken.
- ▶ Push the metal clip on the glass.



sentiotec GmbH | Division of Harvia Group | Wartenburger Straße 31, A-4840 Vöcklabruck
T +43 (0) 7672/22 900-50 | F -80 | info@sentiotec.com | www.sentiotec.com