

# Saunatür Klarglas/Bronze Sauna door clear glass/bronze

## DS40 & DS80

DS40-3CS-590, DS80-3CS-590, DS80-3BS-590

MONTAGEANWEISUNG / INSTALLATION INSTRUCTIONS

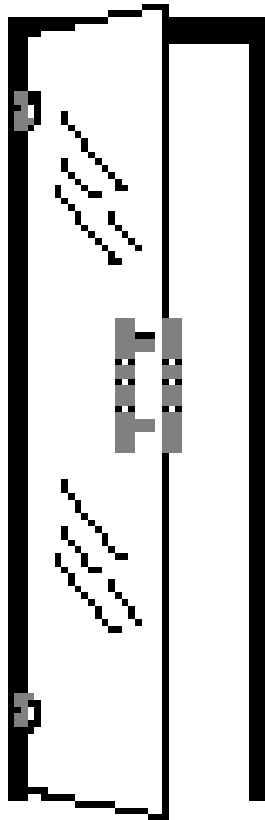

DE

EN

590 mm x 1915 mm

# DS40-3CS-590

(mm)

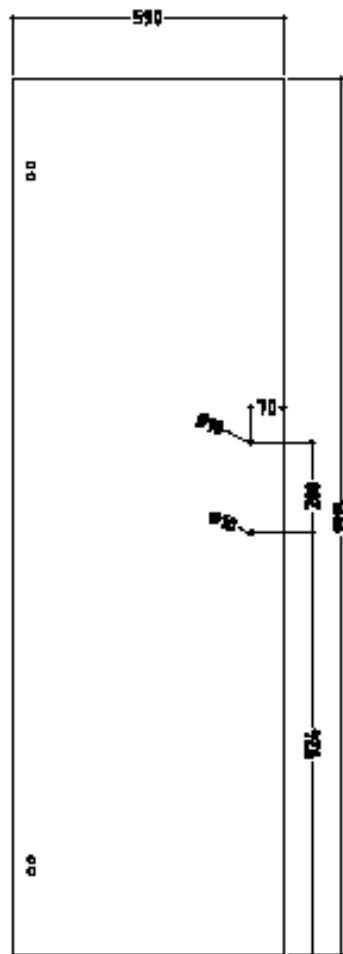
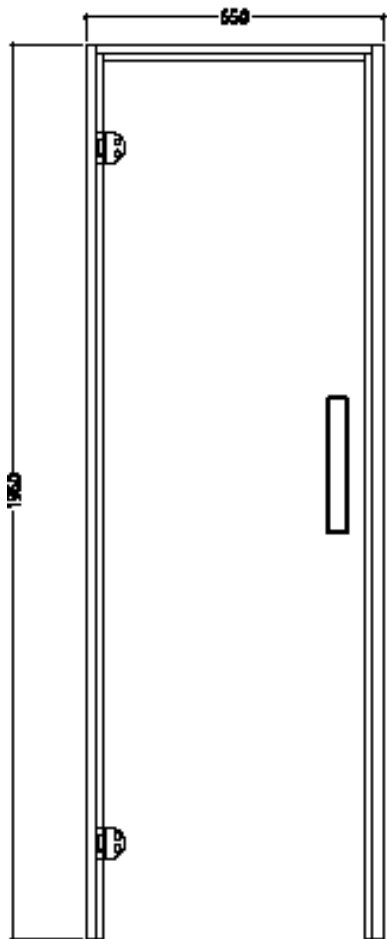
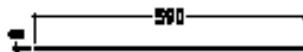
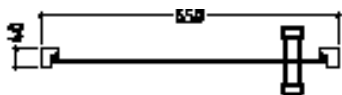

Einscheibensicherheitsglas (ESG) - tempered safety glass

**DS80-3CS-590, DS80-3BS-590**

(mm)

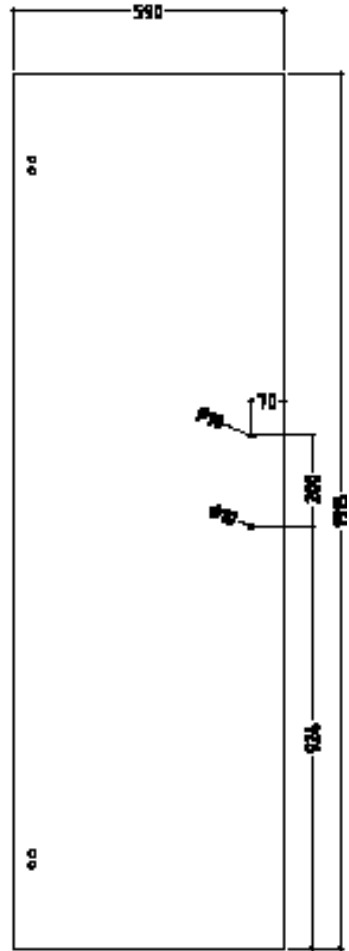
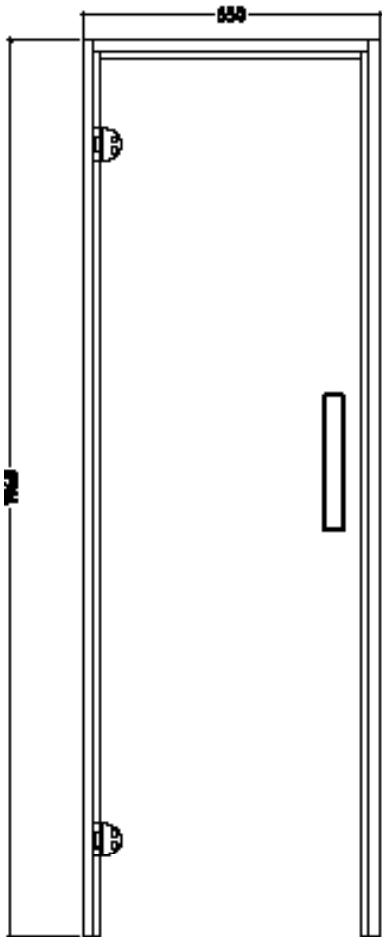
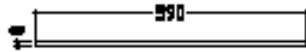
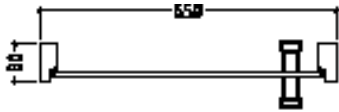

DE  
EN

Einscheibensicherheitsglas (ESG) - tempered safety glass

## Lieferumfang - Scope of supply

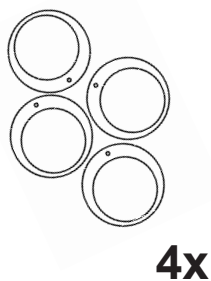
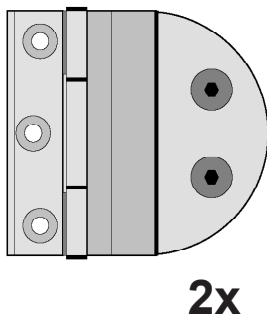
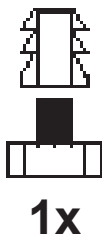
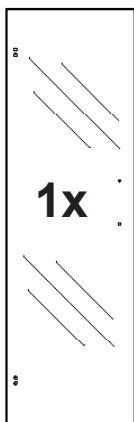

## Montage - Installation

- ▶ Transportleiste entfernen - Remove the transport strip

1

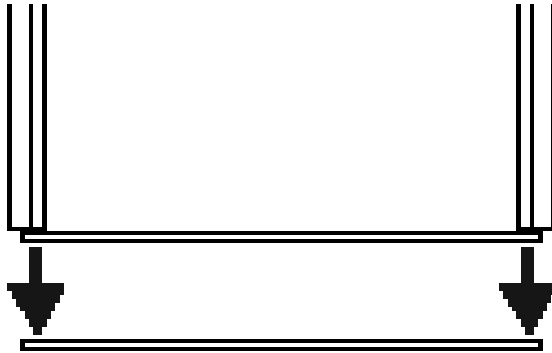

- ▶ Türrahmen montieren - Install door frame

2

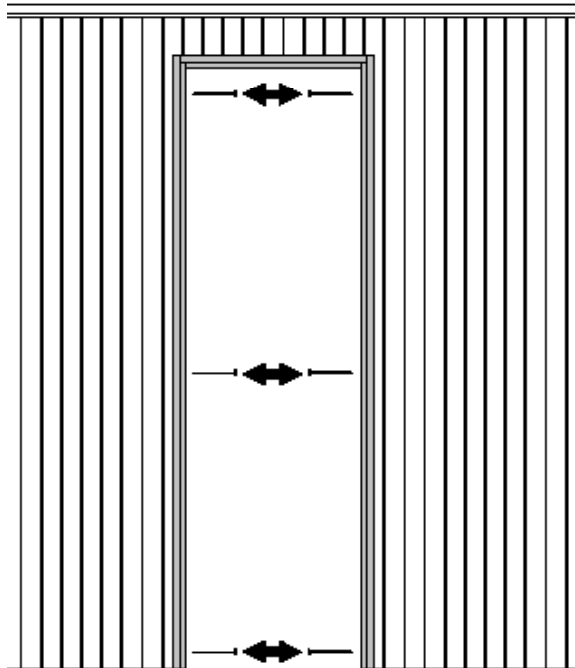

DE

EN

► Beschläge montieren - Assembling door mounting

3

Innenseite - inside

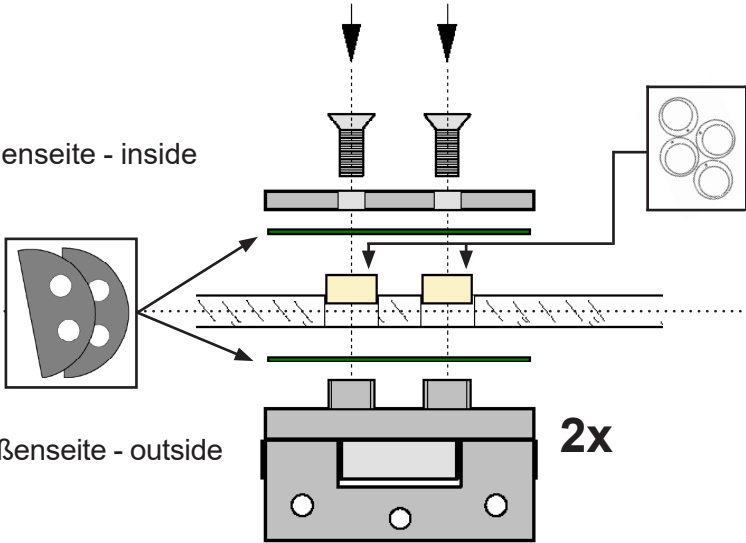

Außenseite - outside

2x

► Glastüre einsetzen - Insert glass door

4

Linksanschlag  
Left stop

oder  
or

Rechtsanschlag  
Right stop

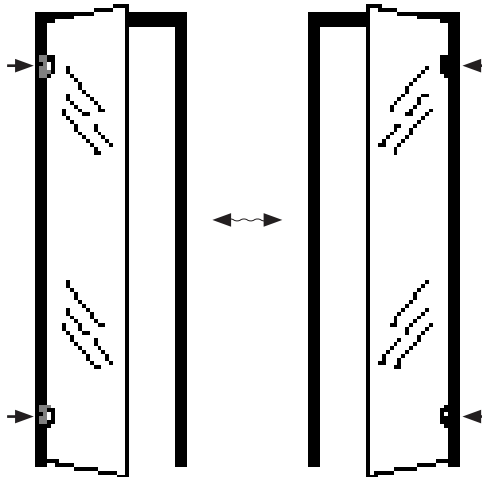

- ▶ Glastüre positionieren - Position glass door

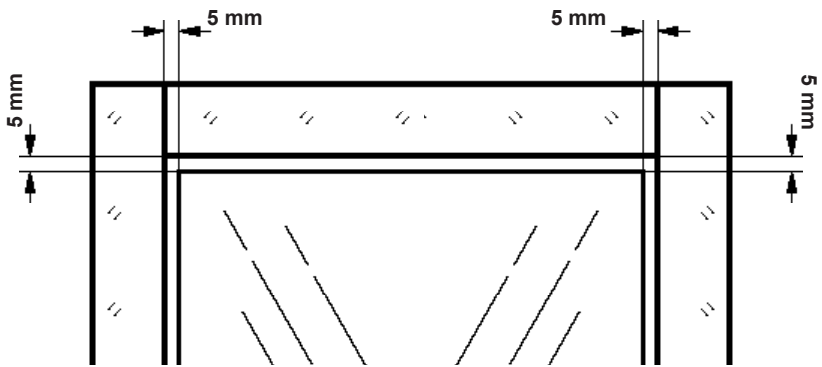
**5**

DE

EN

- ▶ Glastüre montieren - Mount glass door

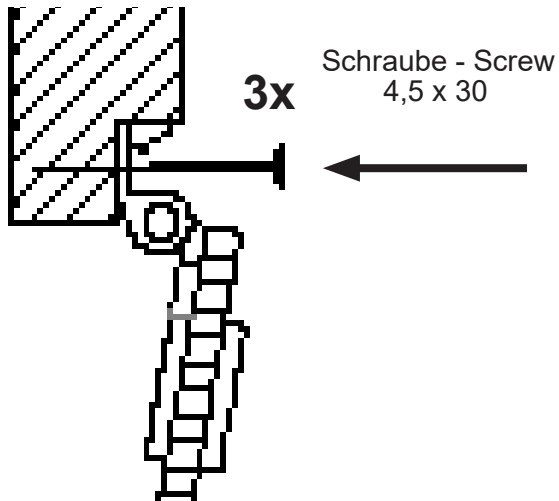
**6**

► Türgriff montieren - Mounting door handle

7

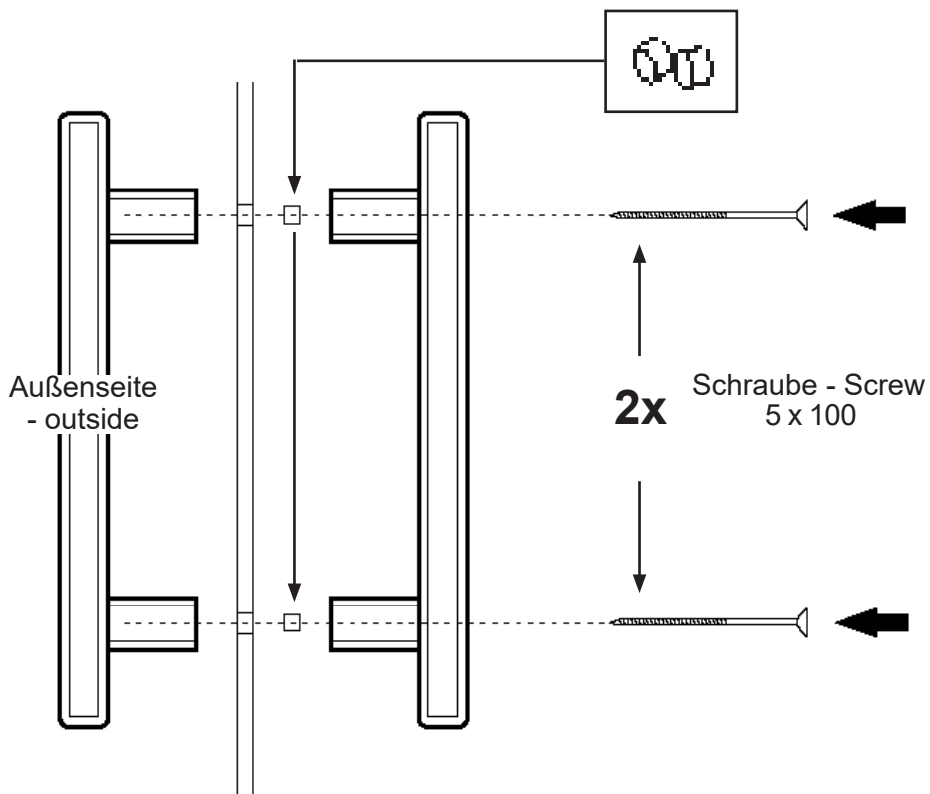



## ► Türmagnet montieren - Mounting door magnet

8

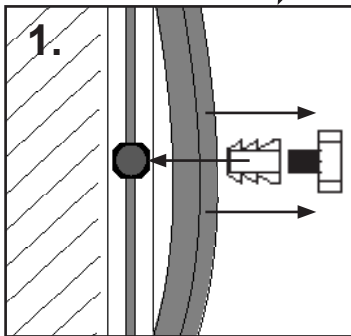
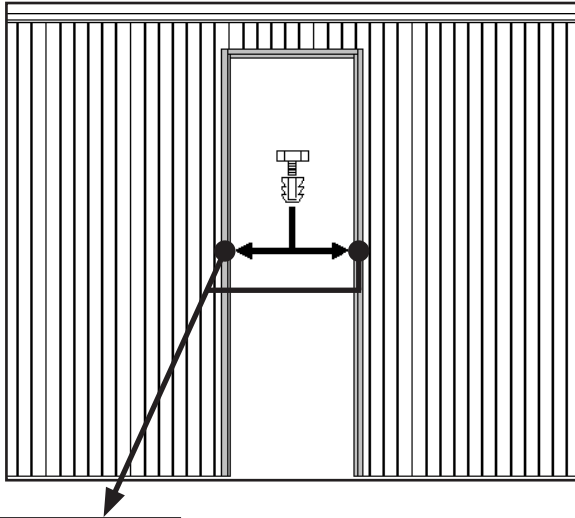

- Dichtband mittig abziehen und Türmagnet in Aussparung drücken.
- Pull sealing tape in the middle and press the door magnet into the hole.

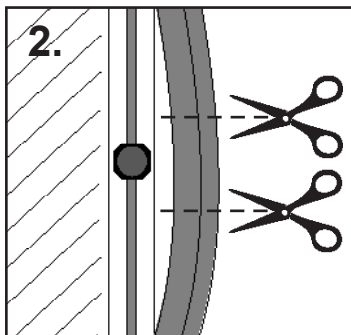

- Dichtband abschneiden.
- Cut the sealing tape.

DE

EN

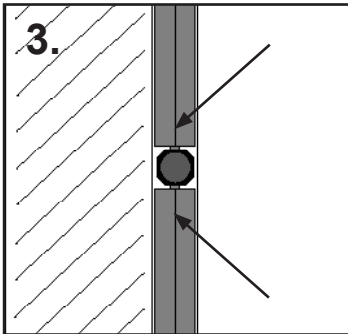

- ▶ Dichtband zurückdrücken.
- ▶ Push the sealing tape back.

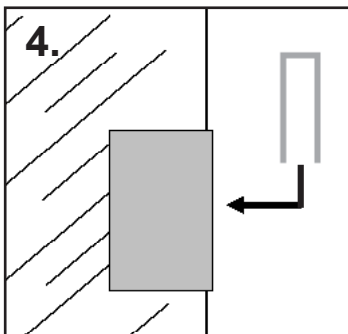

- ▶ Metallklammer auf Glasscheibe drücken.
- ▶ Push the metal clip on the glass.



**HARVIA**

GLOBAL: Harvia Finland Oy | P.O. Box 12 | Teollisuustie 1-7 | 40951 Muurame | FINLAND | +358 207 464 000 | [harvia@harvia.fi](mailto:harvia@harvia.fi)  
CENTRAL EUROPE: Harvia Austria GmbH | Wartenburger Straße 31 | A-4840 Vöcklabruck | +43 (0) 7672/22900-50 | [info@harvia.com](mailto:info@harvia.com)  
[www.harvia.com](http://www.harvia.com)